

# ActCAD 2024 New IntelliCAD 12 核心

電腦軟體共同供應契約(1130201)

第四組 繪圖軟體 項次1-18

# ACTCAD

2024 Act so easy!

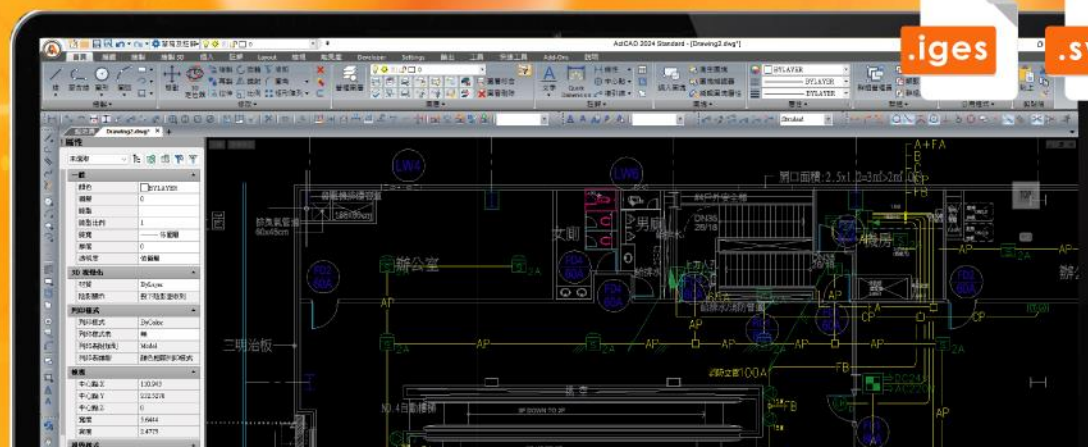



# ACTCAD

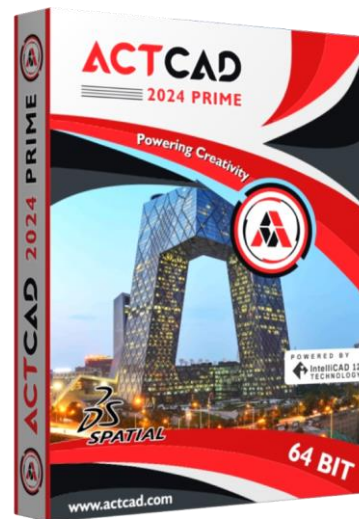
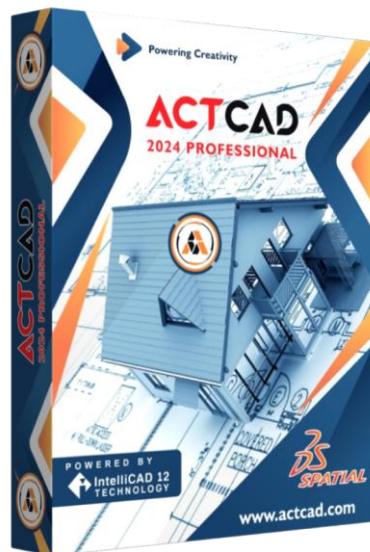
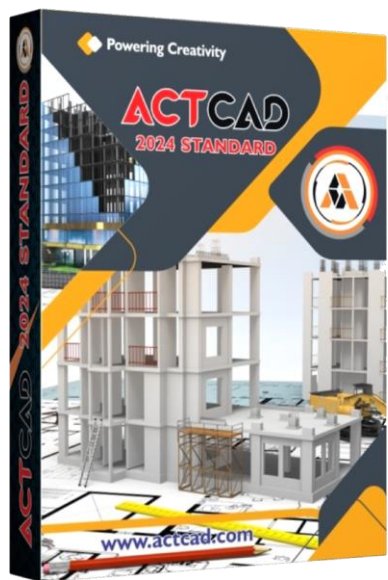

## 永久授權

買斷制，終身使用

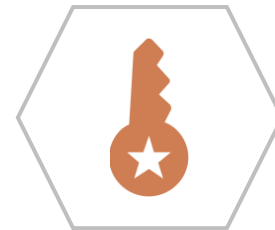

## 靈活授權

依使用環境提供多元授權方式



## 完美相容

相容CAD常使用的DXF/DWG檔



## 價格優勢

正版同業最低價，效能不打折



相容CAD常用的dwg檔案



熟悉的CAD介面



ActCAD 符號圖庫



3.0000

標註樣式管理員

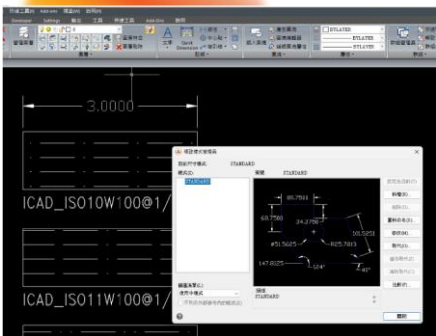

列印PDF



AEC物件：牆、門、窗、屋頂、地板...等



擁有3D建模功能

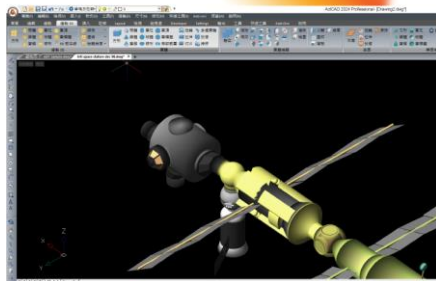

## 比較 ActCAD 與 AutoCAD

	ActCAD 標準版	ActCAD 專業版	ActCAD 專業進階版	AutoCad	AutoCad LT
<b>授權</b>					
終身授權 永久買斷	V	V	V	-	-
靈活的授權方式(序號金鑰/USB加密/區網授權)	V	V	V	-	-
授權資格全球有效，不受地域限制	V	V	V	-	-
無資格限制，全功能免費試用15天	V	V	V	-	-
一鍵快速授權轉移	V	V	V	-	-
<b>檔案格式</b>					
支援 R2.5 至 2018的 DWG 和 DXF 文件	V	V	V	V	V
支援 DWG 和 DXF 檔案的本機格式	V	V	V	V	V

\*詳細內容請參考網站資料



## 靈活的授權方式

序號金鑰



單一電腦安裝使用  
輸入正式授權序號  
即可開始啟用軟體

- ✓ 安裝於個人電腦，便利的授權轉移流程

USB加密



單一電腦安裝使用  
插入USB驅動授權  
即可開始啟用軟體

- ✓ 個人有多台電腦或多人不同電腦使用時，只需重新插入USB後即可使用軟體

\*使用軟體時需全程搭配USB\*

區網授權

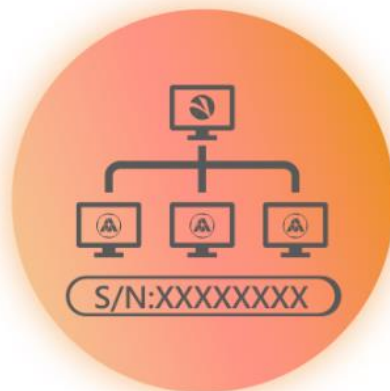

可多台電腦安裝使用  
最大使用數取決於購買的授權數量  
須同網域做好主機端與用戶端設定

- ✓ 授權數較彈性，可降低企業成本  
適企業多人共享

\*詳細的區網授權設定  
請查看[安裝手冊設定流程](#)

## 系統需求：

- 作業系統：Windows 11/10，64位元
- CPU：3GHz以上
- 記憶體：16GB以上
- 磁碟空間：SSD
- 介面：USB 2.0 Port\*1個 (僅限USB加密的授權方式)
- 獨立顯卡或繪圖專用卡

# 快速安裝說明

- 到官網下載軟體

ActCAD 2024 標準版

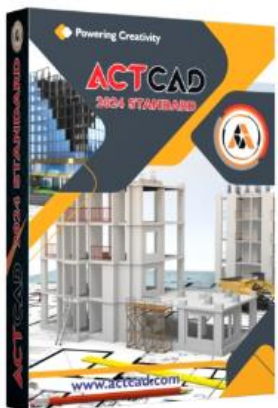

- 易上手的2D繪圖軟體
- 支援64位元作業系統
- 採用最新版IntelliCAD程式核心
- 永久授權

試用下載

版本編號：12.0.1168.0

- 下載成功，請先解壓縮資料夾，完成2個檔案的安裝



- 安裝完2個檔案，即可開啟軟體，將語言轉換成繁中

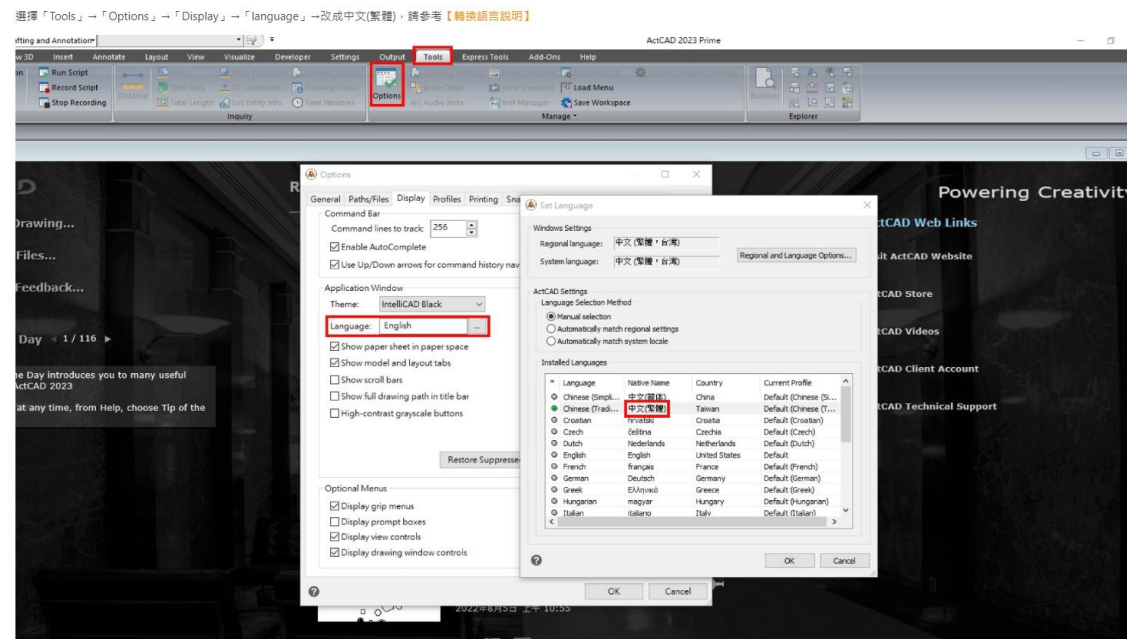
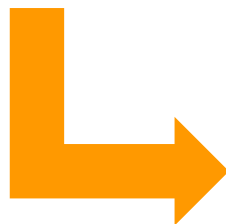

# 資安控管 可離線授權



請至ActCAD 安裝完成的bin資料夾裡，將.dat檔案提供給我們，以進行離線手動啟用授權程序

詳細路徑圖文說明如下(以2022 Standard版安裝在C槽為例)

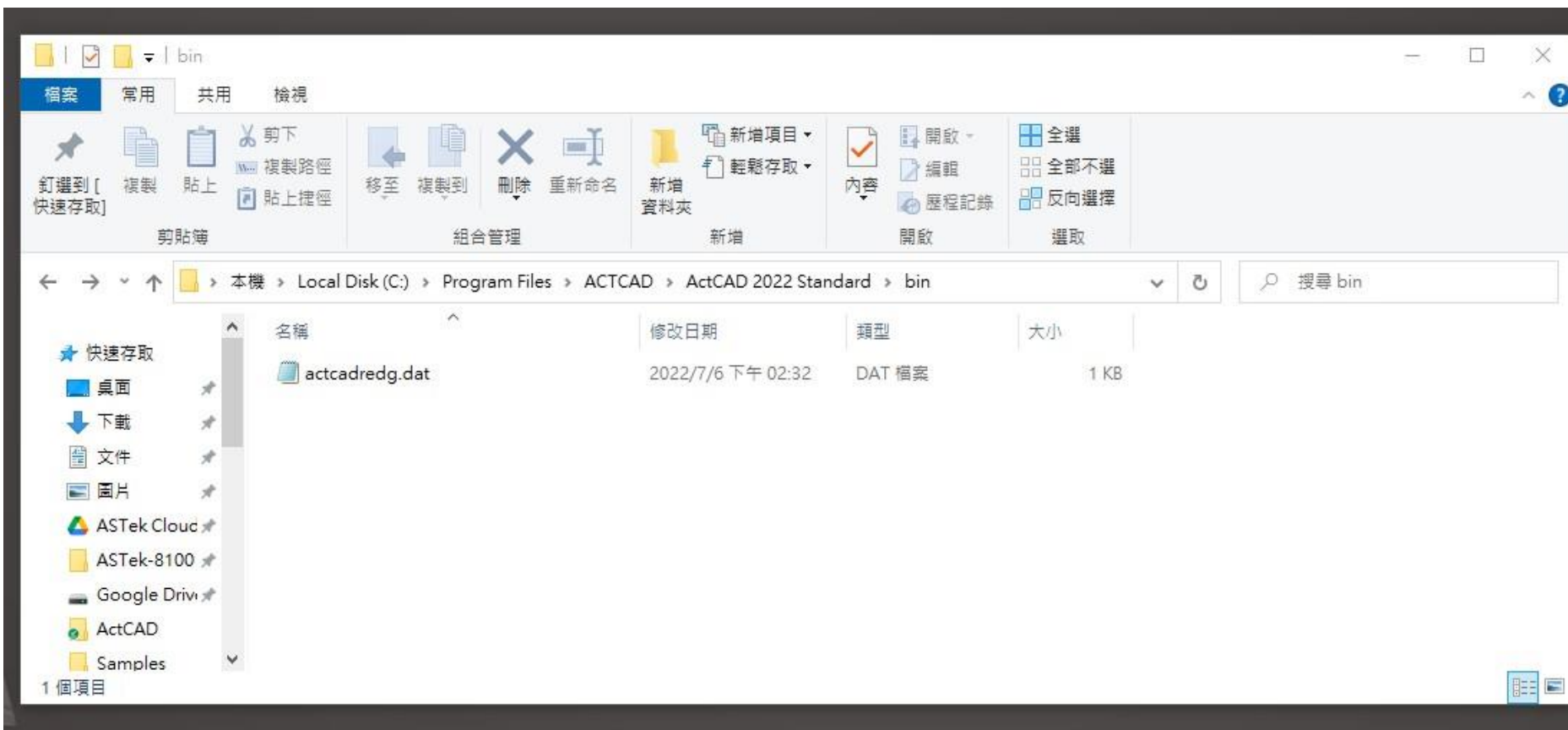



# 版本更新3步驟

1

查詢ActCAD版本編號

路徑：說明→關於ActCAD



2

以系統管理員身分執行  
License Transfer 授權轉移

路徑：Add-Ons→ License Transfer

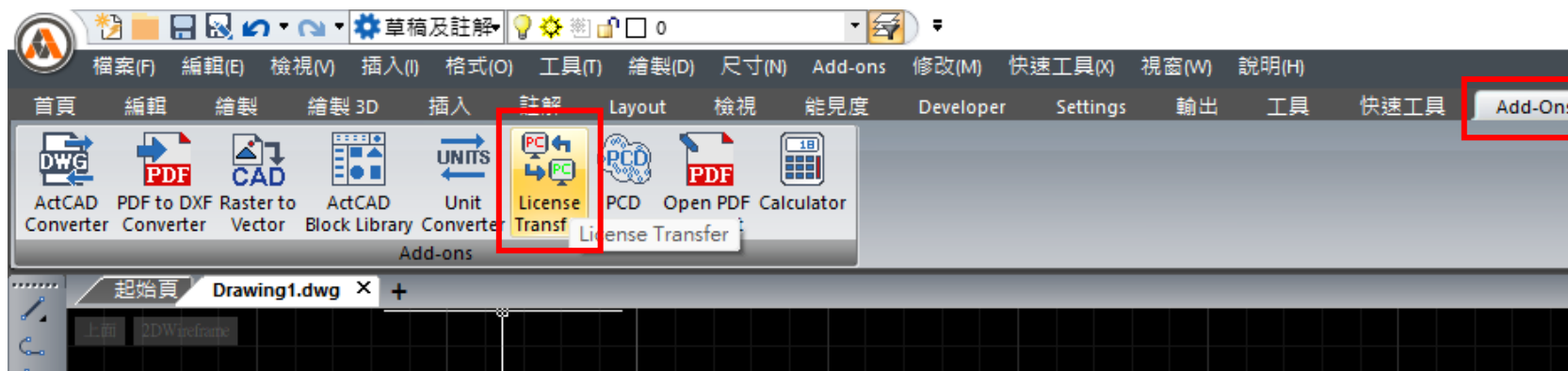

3

轉移成功，移除舊的主程式與中文套件  
下載最新軟體程式，並進行授權啟用程序

ActCAD 2023 Standard x64 11.0.777   Jytra Technology Solutions Private Limited   2023/1/3	2	3.63 GB ...
ActCAD 2023 中文化 2023/9/26	1	...

# ActCAD 台灣用戶









熟悉的CAD軟體  
終身授權 · 操作自如

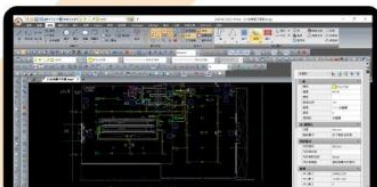

## ActCAD Taiwan

@actcadtaiwan · 147位訂閱者 · 585 部影片

ActCAD Taiwan以「提升企業競爭力的合法CAD軟體」為前提，提供客戶使用「合法軟體」顯示更多

actcad.com.tw 和另外 1 個連結



訂閱

首頁 影片 直播 播放清單 社群

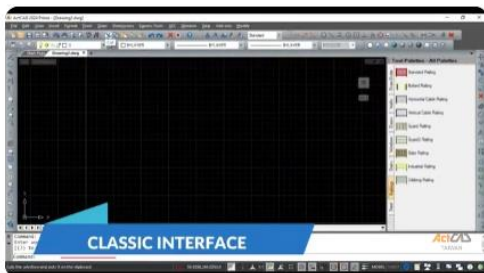

### ActCAD | 2024 Features

觀看次數：368次 · 5個月前

#ActCADTaiwan 官方網站：<http://actcad.com.tw>  
ActCAD是一款擁有2D繪圖和3D建模、建築師及其他技術顧問，並可與CAD軟體。ActCAD源自於IntelliCAD新發布的IntelliCAD版本為其用戶加命令和功能，完美地融合功能。我們的客戶帶來龐大的效益及競爭力。

### ActCAD 常見問題解決 ▶ 全部播放

- 如何轉換語言/開啟舊檔/開新檔案 (請開啟CC字幕) 1:51
- 【序號金鑰】如何進行授權轉移 License Transfer 0:52
- 面板工具列與傳統功能表切換 (請開啟CC字幕) 1:24
- 設定檔複製 2:14
- 自訂工具列 (請開啟CC字幕) 1:03
- 輸入相容性設定 (請開啟CC字幕) 0:52

### ActCAD Taiwan E-Learning ▶ 全部播放

- 如何使用DWG to PDF.pc3匯出PDF 1:18
- 如何解決未找到 Irx 檔案問題 0:59
- Rotate view -90 0:22
- 如何建立相機 0:46
- 提取資料 3:08
- 管理檢視 0:20



# ActCAD 2024 新功能介紹

- 超級剖面線
- 幾何中心捕捉
- 快速屬性
- 使用控制頂點或擬合點繪製曲線
- 新增更多AEC功能
- 自定義 AEC 樣式

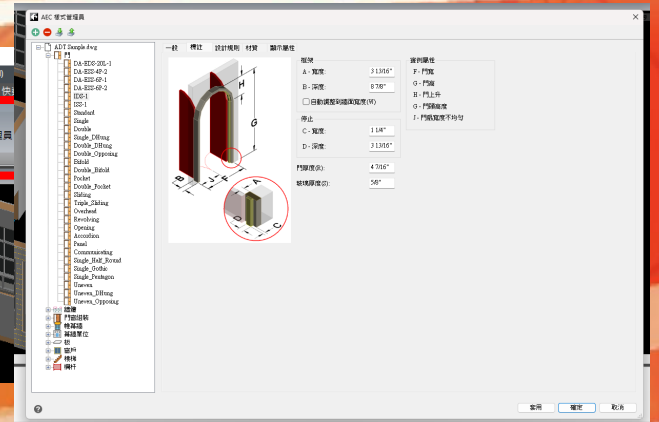
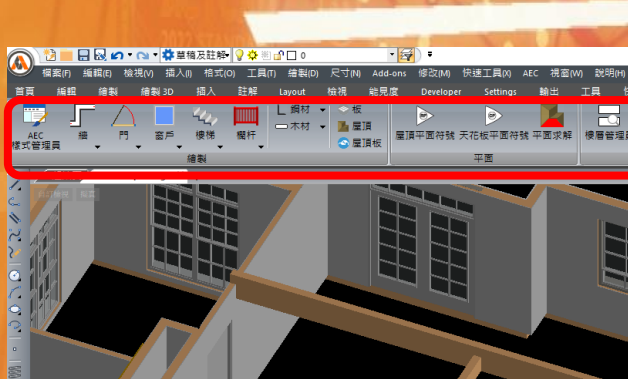
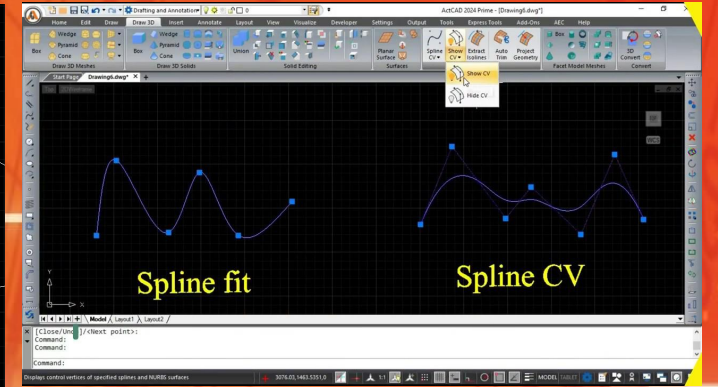
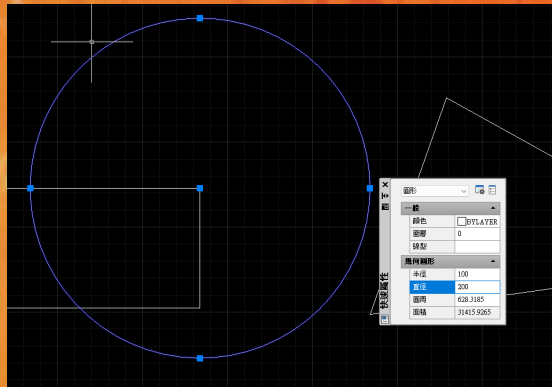
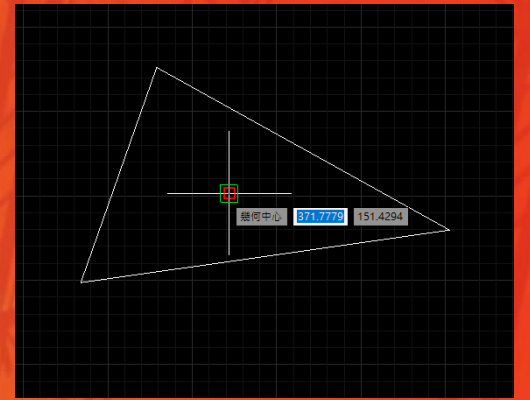
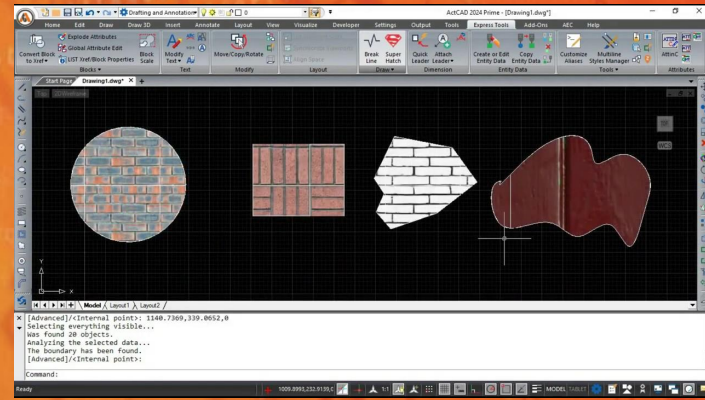



## SUPER HATCH

### 超級剖面線

除了ActCAD內建豐富的剖面線選擇，SUPERHATCH 指令可使用圖像、材質、圖塊、外部參照來建立剖面線，更清楚分辨圖面內容

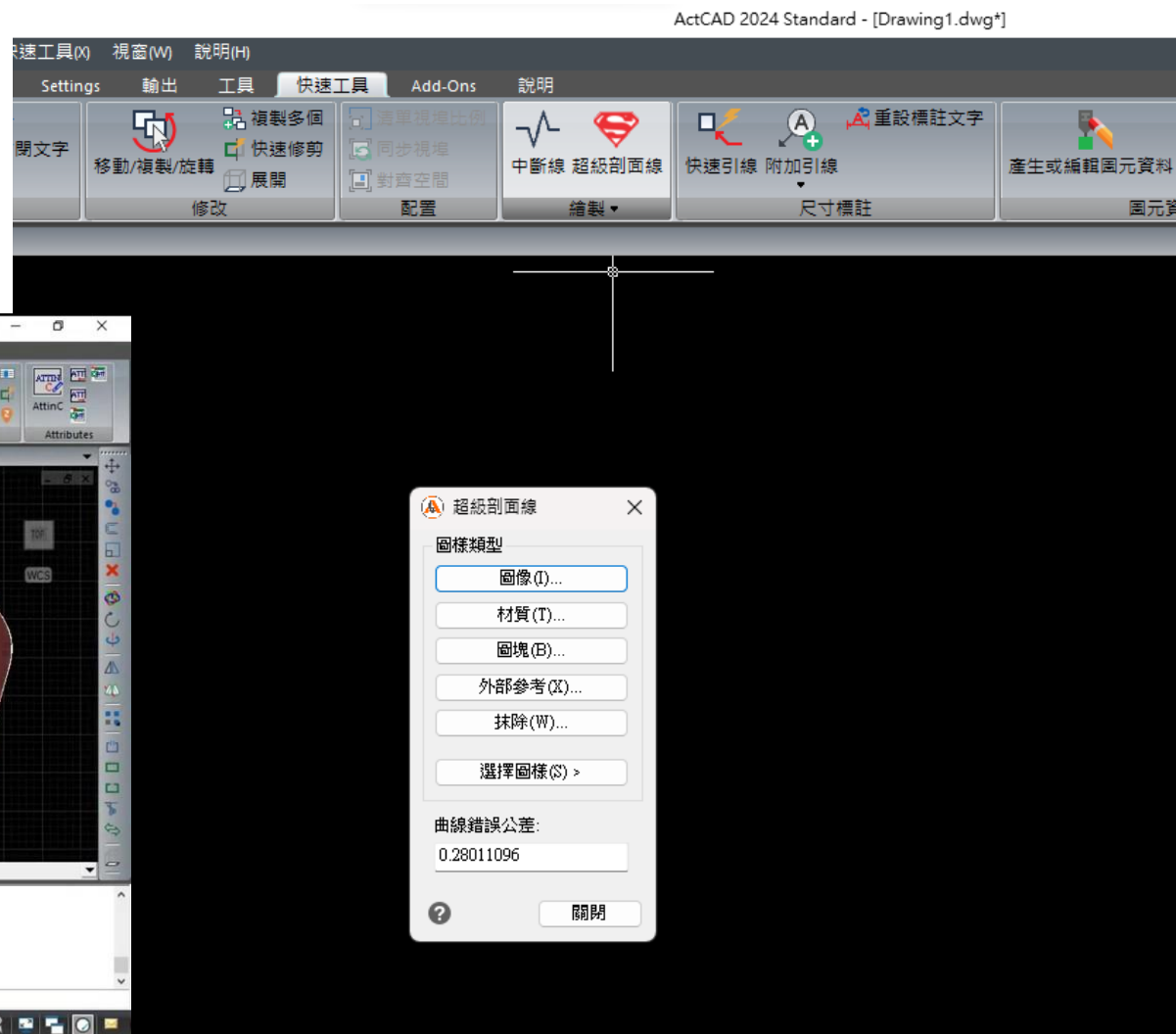
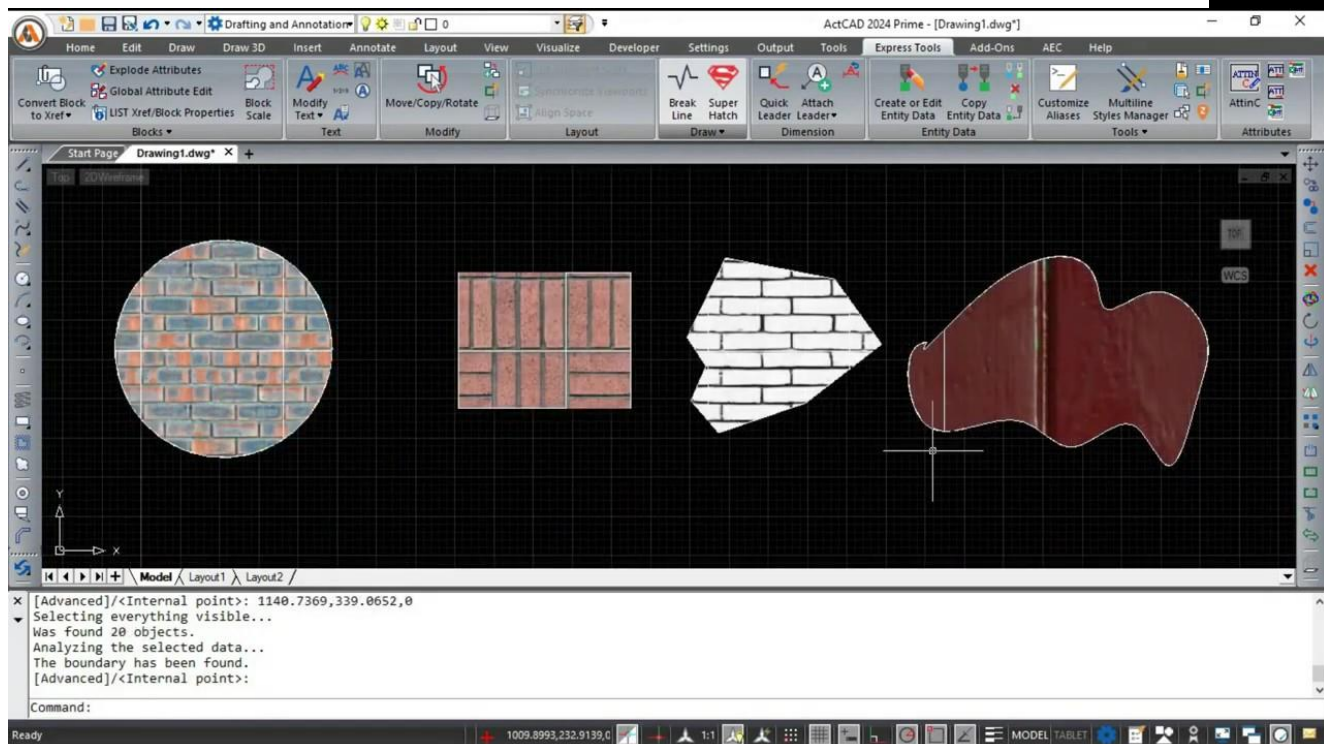

## GEOMETRIC CENTER SNAP

### 幾何中心捕捉

可以快速捕捉幾何圖形的中心點

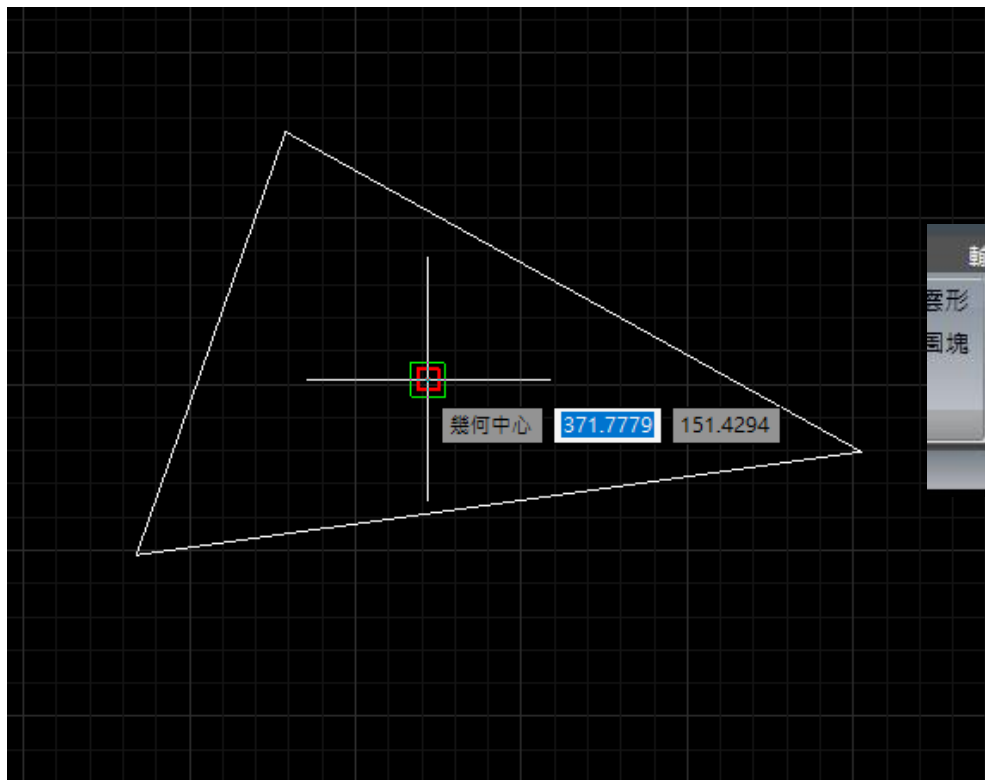

## QUICK PROPERTIES

### 快速屬性

可以快速查看及簡易修改常用屬性

Ex: 尺寸、文字內容...等

# ActCAD 2024 新上市

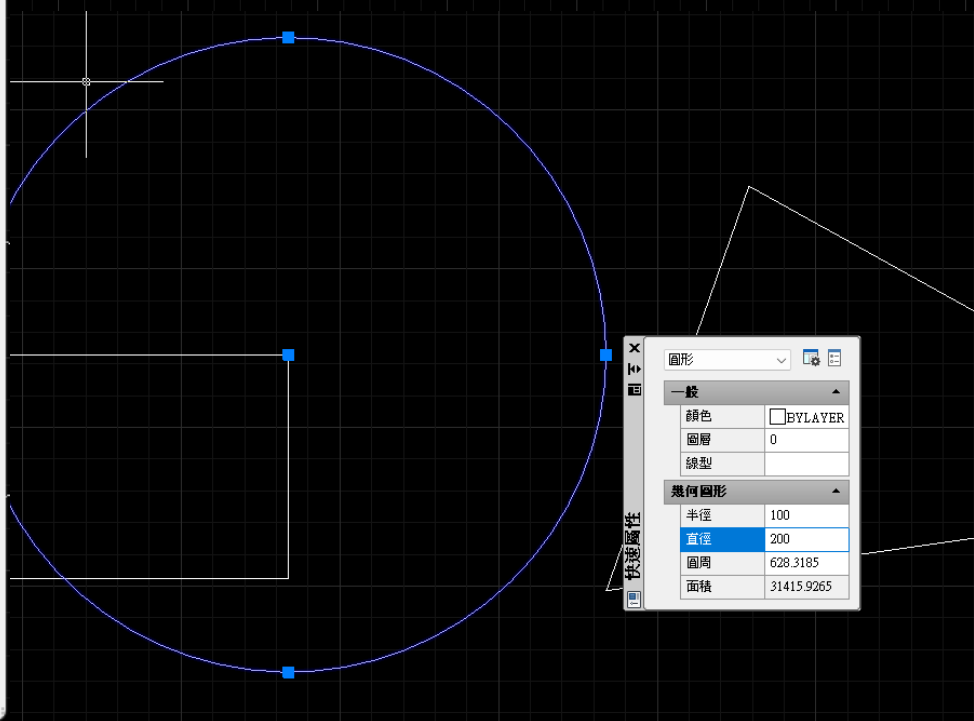
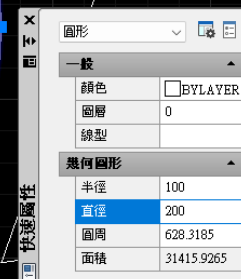
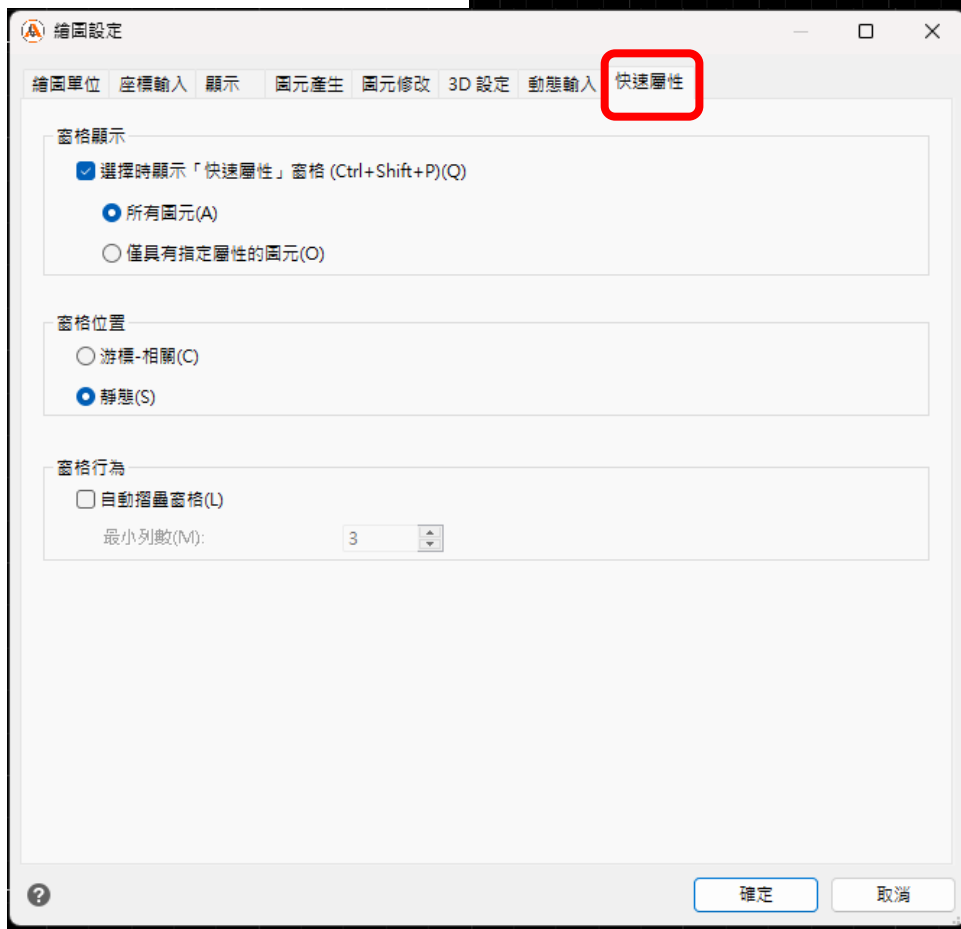



# 新功能-全版本

## SPLINE CV & SPLINE FIT

使用控制頂點或擬合點繪製曲線

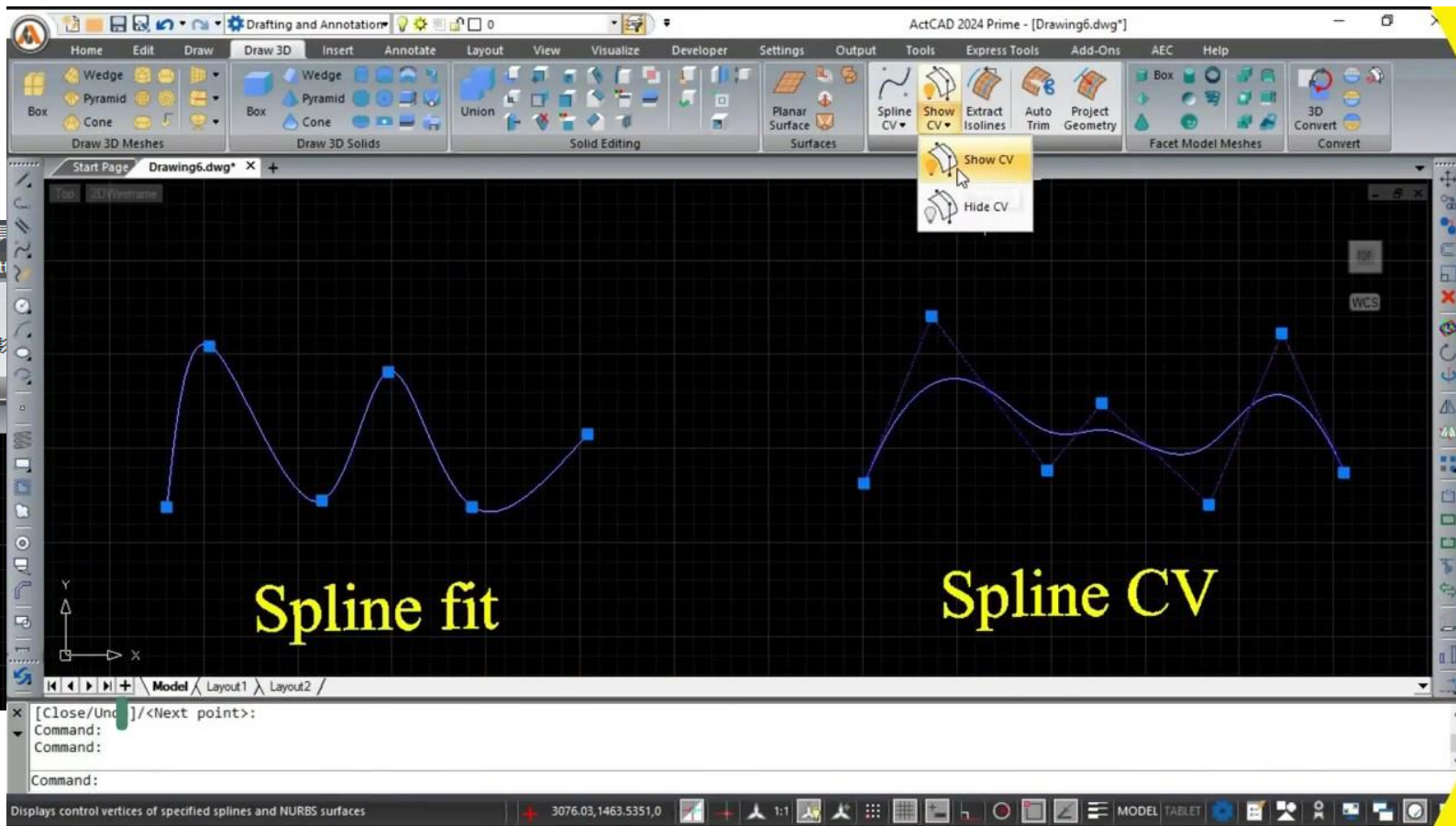
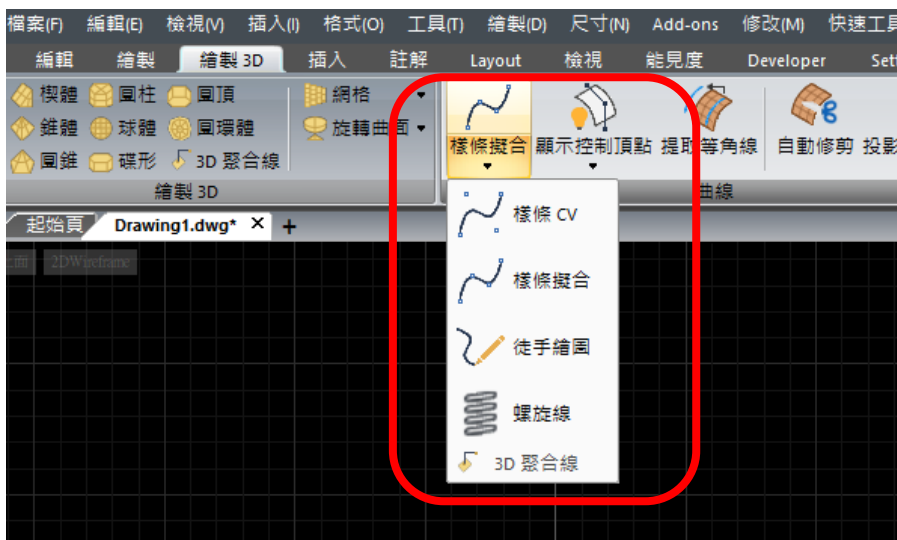

## 新增更多AEC功能

- 將屋頂和天花板平面符號附加到牆壁上並引用它們，同時以交互方式創建屋頂和天花板平面
- 為 AEC 圖元指定級別，導入具有更多選項的.ifc檔，並在匯出為.ifc檔時包括.rvt 和.ifc 參考底圖

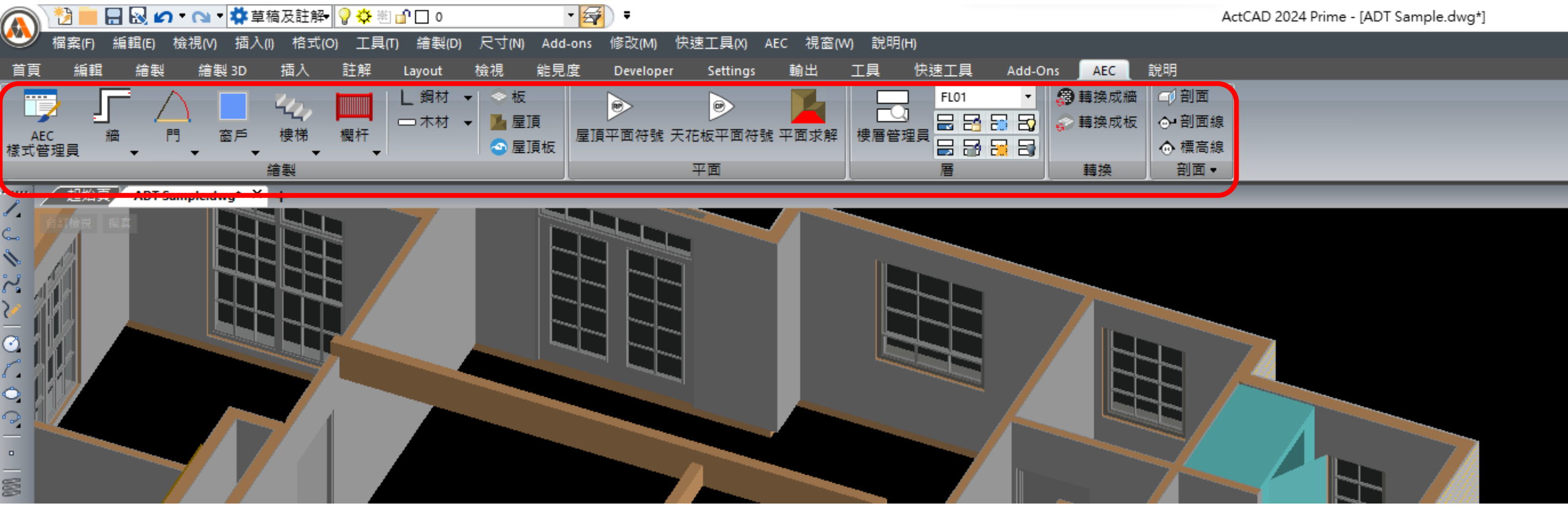

## CUSTOMIZE AEC STYLES

### 自定義 AEC 樣式

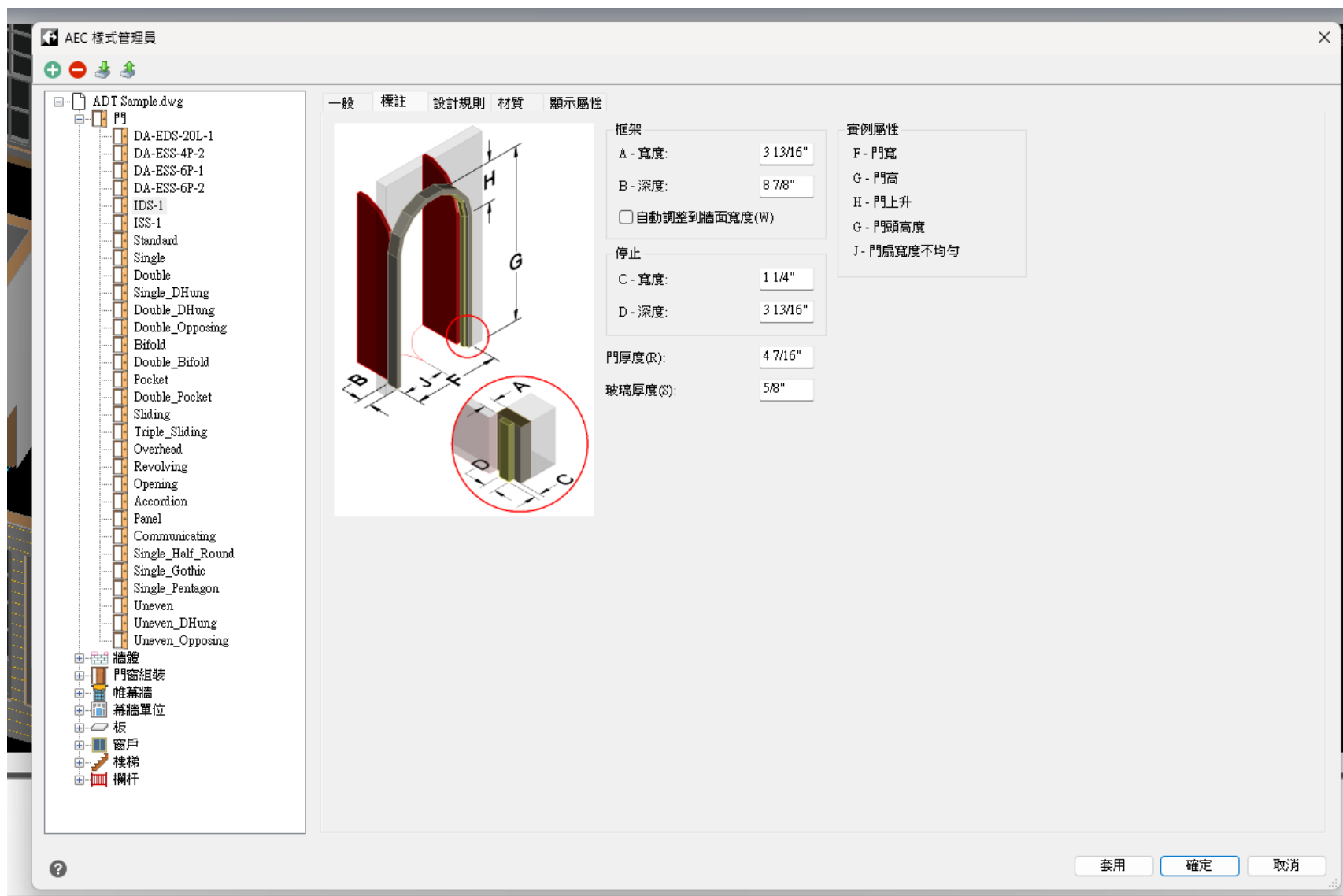



# 感謝觀看

actcad.com.tw

sales@actcad.com.tw

Line ID: @actcad\_tw

# ACTCAD

2024 Act so easy!

